

RSC Series

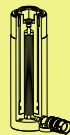

Capacity:
5-100 ton

Stroke:
16-362mm

Maximum Operating Pressure:
700 bar

RSC 液壓單動彈簧回縮，外牙式千斤頂

- 液壓缸外螺牙及底座螺孔便於固定。(詳見規範)
- 主軸內螺牙(5ton~30ton)便於安裝於特製工件或設計。
- 主軸上的銅合金圈可預防偏心荷載所造成的刮傷。
- 主軸硬路處理耐磨、抗腐蝕。
- 油缸內壁硬路處理，於高濕度氣候更耐磨、抗腐蝕。
- 防塵環減少污染物附著。
- 上螺帽保護主軸超揚昇及全揚程荷載。
- 表面粉體塗裝美觀抗腐蝕、防銹。
- 外螺牙均含保護套。
- 各型號均含SQB-3/8UF快速接頭及防塵蓋。

Single-Acting, Spring return Collar thread Cylinders

- ※ Equip with collar thread and base holes (on most model), for greater flexibility in mounting onto fixture. (see page 16 for details)
- ※ Equip with inner plunger thread (5 ton to 30 ton) for greater flexibility in designing fixture.
- ※ Bronze alloy bearing on plunger to minimize scoring due to off-centre load.
- ※ Hard chrome plated plunger to resist wear and corrosion.
- ※ Inner barrel wall are hard chrome plated to resist wear and corrosion in high humidity atmosphere.
- ※ Equip with wiper seals to prevent ingress of dirt.
- ※ Equip with stop-ring to prevent plunger blow-out and withstands full "Dead-End" load.
- ※ Powder coated finish for greater corrosion protection.
- ※ Equip with plastic cap to protect collar threads.
- ※ Come with SQB-3/8UF female coupler & dust cap.

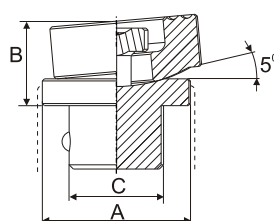

XKCAT-10, 50

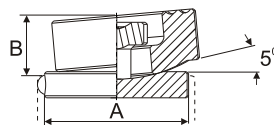

XKCAT-100

選配墊塊尺寸 Optional Saddle Dimensions (mm)

油壓缸 型號-能力 Cylinder Model/Cap. (ton)	型號 樣式：傾斜墊塊 Model Number Type : Tilt	A	B	C
RSC-10, RSC-15 Except RSC-101	XKCAT-10	35	20	22
RSC-25, RSC-30	XKCAT-50	50	21	35
RSC-50, RSC-75 RSC-100	XKCAT-100	71	24	-



墊塊/鞍座 Saddle

RSC-系列 均配有高硬度可移除式溝槽墊塊於起重時具防滑作用。偏心起重時請選用傾斜墊塊。

RSC-Series are equipped with hardened removable "Ribbed saddles" to prevent slippage during jacking. For off-center loading application, see optional tilting saddle.

	焊提把 Weldable
	吊環螺栓 Eyebolt
	活動提把 Removable strap handles
	螺牙式活動提把 Thread

提把型式 Handle type	
(S)	標準配件 standard equipped
(O)	選配 option
●	焊提把 Weldable
★	吊環螺栓 Eyebolt
▲	活動提把 Removable strap handles
■	螺牙式活動提把 Thread

快速規範 QUICK SELECTION CHART									
提把型式 Handle type	型號 Model Number	能力 Cylinder Capacity	揚程 Stroke	受壓面積 Cylinder Effective Area	總油量 Oil Capacity	本身高 Collapsed Height	主軸內牙 Plunger internal Thread	重量 Weight	
(O) (S)		ton (kN)	(mm)	(cm ²)	(cm ³)	A (mm)	O (in)	(kg)	
	RSC-50	5 (45)	16	6.5	10	41	—*	1.0	
	RSC-51		25	6.5	16	110	3/4"-16	1.0	
	RSC-53		76	6.5	50	165	3/4"-16	1.5	
	RSC-55		127	6.5	83	215	3/4"-16	1.9	
	RSC-57		177	6.5	115	273	3/4"-16	2.4	
	RSC-59	232	6.5	151	323	3/4"-16	2.8		
	RSC-101	10 (101)	26	14.5	38	89	#10-24UN	1.8	
	RSC-102		54	14.5	78	121	1"-8	2.3	
	RSC-104		105	14.5	152	171	1"-8	3.3	
	RSC-106		156	14.5	226	247	1"-8	4.4	
	RSC-108		203	14.5	294	298	1"-8	5.4	
	RSC-1010		257	14.5	373	349	1"-8	6.4	
	RSC-1012		304	14.5	441	400	1"-8	6.8	
	RSC-1014		356	14.5	516	450	1"-8	8.2	
	RSC-151		15 (142)	25	20.3	51	124	1"-8	3.3
	RSC-152			51	20.3	104	149	1"-8	4.1
	RSC-154	101		20.3	205	200	1"-8	5.0	
	RSC-156	152		20.3	308	271	1"-8	6.8	
	RSC-158	203		20.3	411	322	1"-8	8.2	
	RSC-1510	254		20.3	516	373	1"-8	9.5	
	RSC-1512	305		20.3	619	423	1"-8	10.9	
	RSC-1514	356		20.3	723	474	1"-8	11.8	
	RSC-251	25 (232)	26	33.2	86	139	1 1/2"-16	5.9	
	RSC-252		50	33.2	166	165	1 1/2"-16	6.4	
	RSC-254		102	33.2	339	215	1 1/2"-16	8.2	
	RSC-256		158	33.2	525	273	1 1/2"-16	10.0	
	RSC-258		210	33.2	697	323	1 1/2"-16	12.2	
	RSC-2510		261	33.2	867	374	1 1/2"-16	14.1	
	RSC-2512		311	33.2	1033	425	1 1/2"-16	16.3	
	RSC-2514		362	33.2	1202	476	1 1/2"-16	17.7	
	RSC-308		30(295)	209	42.1	880	387	—	18.1
	RSC-502		50 (498)	51	71.2	362	176	—	15.0
■	RSC-504	101		71.2	719	227	—	19.1	
■	RSC-506	159		71.2	1131	282	—	23.1	
▲	RSC-5013		337	71.2	2399	460	—	37.6	
▲	RSC-756	75 (718)	156	102.6	1601	285	—	29.5	
▲	RSC-7513		333	102.6	3417	492	—	59.0	
▲ ●	RSC-1004	100 (933)	102	133.3	1355	204	—	33.1	
▲ ★	RSC-1006		168	133.3	2239	357	—	59.0	
▲ ★	RSC-1008		203	133.3	2709	357	—	59.0	
▲ ★	RSC-10010		260	133.3	3466	449	—	72.6	



RSC-25噸 復軌實例應用
RSC-25 ton rail way application



RSC & 泵浦特殊訂製
RSC & Pump -specific purpose

* RSC-50油壓缸具不可拆卸溝槽墊塊且無外螺牙
RSC-50 cylinder has non-removable grooved saddle and no collar thread.

型號 Model Number	外部尺寸 Outer Dimension												
	能力 Cylinder Capacity	揚程 Stroke	受壓面積 Cylinder Effective Area	總油量 Oil Capacity	本身高 Collapsed Height	伸長總高 Extended Height	外徑 Outside Diam.	內徑 Cylinder Bore Diam.	主軸直徑 Plunger Diam.	底部前進油孔位置 Base to Adv. Port	墊塊直徑 Saddle Diam.	突出高度 Saddle Protrusion from Plngr.	
	ton(kN)	(mm)	(cm ²)	(cm ³)	A (mm)	(mm)	D (mm)	E (mm)	F (mm)	H (mm)	J (mm)	K (mm)	
RSC-50	5 (45)	16	6.5	10	41	57	58	28.7	25.4	19	—*	—*	
RSC-51		25	6.5	16	110	135	38	28.7	25.4	19	25	6	
RSC-53		76	6.5	50	165	241	38	28.7	25.4	19	25	6	
RSC-55		127	6.5	83	215	342	38	28.7	25.4	19	25	6	
RSC-57		177	6.5	115	273	450	38	28.7	25.4	19	25	6	
RSC-59		232	6.5	151	323	555	38	28.7	25.4	19	25	6	
RSC-101		10 (101)	26	14.5	38	89	115	57	42.9	38.1	19	—	—
RSC-102	54		14.5	78	121	175	57	42.9	38.1	19	35	6	
RSC-104	105		14.5	152	171	276	57	42.9	38.1	19	35	6	
RSC-106	156		14.5	226	247	403	57	42.9	38.1	19	35	6	
RSC-108	203		14.5	294	298	501	57	42.9	38.1	19	35	6	
RSC-1010	257		14.5	373	349	606	57	42.9	38.1	19	35	6	
RSC-1012	304		14.5	441	400	704	57	42.9	38.1	19	35	6	
RSC-1014	356		14.5	516	450	806	57	42.9	38.1	19	35	6	
RSC-151	15 (142)		25	20.3	51	124	149	69	50.8	41.4	19	38	9
RSC-152			51	20.3	104	149	200	69	50.8	41.4	19	38	9
RSC-154		101	20.3	205	200	301	69	50.8	41.4	19	38	9	
RSC-156		152	20.3	308	271	423	69	50.8	41.4	25	38	9	
RSC-158		203	20.3	411	322	525	69	50.8	41.4	25	38	9	
RSC-1510		254	20.3	516	373	627	69	50.8	41.4	25	38	9	
RSC-1512		305	20.3	619	423	728	69	50.8	41.4	25	38	9	
RSC-1514		356	20.3	723	474	830	69	50.8	41.4	25	38	9	
RSC-251	25 (232)	26	33.2	86	139	165	85	65.0	57.2	25	50	10	
RSC-252		50	33.2	166	165	215	85	65.0	57.2	25	50	10	
RSC-254		102	33.2	339	215	317	85	65.0	57.2	25	50	10	
RSC-256		158	33.2	525	273	431	85	65.0	57.2	25	50	10	
RSC-258		210	33.2	697	323	533	85	65.0	57.2	25	50	10	
RSC-2510		261	33.2	867	374	635	85	65.0	57.2	25	50	10	
RSC-2512		311	33.2	1033	425	736	85	65.0	57.2	25	50	10	
RSC-2514		362	33.2	1202	476	838	85	65.0	57.2	25	50	10	
RSC-308		30(295)	209	42.1	880	387	596	101	73.2	57.2	57	50	10
RSC-502		50 (498)	51	71.2	362	176	227	127	95.2	79.5	33	71.5	2
RSC-504	101		71.2	719	227	328	127	95.2	79.5	33	71.5	2	
RSC-506	159		71.2	1131	282	441	127	95.2	79.5	35	71.5	2	
RSC-5013	337		71.2	2399	460	797	127	95.2	79.5	35	71.5	2	
RSC-756	75 (718)	156	102.6	1601	285	441	146	114.3	95.2	30	71	5	
RSC-7513		333	102.6	3417	492	825	146	114.3	95.2	30	71	5	
RSC-1004	100 (933)	102	133.3	1355	204	306	177	130.3	104.9	41	71	2	
RSC-1006		168	133.3	2239	357	525	177	130.3	104.9	41	71	2	
RSC-1008		203	133.3	2709	357	576	177	130.3	104.9	41	71	2	
RSC-10010		260	133.3	3466	449	709	177	130.3	104.9	41	71	2	

*RSC-50油壓缸具不可拆卸溝槽墊塊且無外螺牙
RSC-50 cylinder has non-removable grooved saddle and no collar thread.

型號 Model Number	牙紋尺寸 Threads Dimension				底座螺孔 Base Mounting Holes			重量 Wt. (kg)
	主軸內牙 Plunger Internal Thread	內牙深度 Plunger Thread Length	油缸外牙 Collar Thread	外牙長度 Collar Thread Length	底座孔距 Bolt Circle	底座螺紋 Thread	螺紋深度 Thread Depth	
	O (in)	P (mm)	W (in)	X (mm)	U (mm)	V (in)	Z (mm)	
RSC-50	—*	—*	—	—	28	5.6mm	—	1.0
RSC-51	3/4"-16	14	1 1/2"-16	28	25	1/4"-20UN	14	1.0
RSC-53	3/4"-16	14	1 1/2"-16	28	25	1/4"-20UN	14	1.5
RSC-55	3/4"-16	14	1 1/2"-16	28	25	1/4"-20UN	14	1.9
RSC-57	3/4"-16	16	1 1/2"-16	28	25	1/4"-20UN	14	2.4
RSC-59	3/4"-16	16	1 1/2"-16	28	25	1/4"-20UN	14	2.8
RSC-101	#10-24UN	6	2 1/4"-14	26	39	5/16"-18UN	12	1.8
RSC-102	1"-8	19	2 1/4"-14	26	39	5/16"-18UN	12	2.3
RSC-104	1"-8	19	2 1/4"-14	26	39	5/16"-18UN	12	3.3
RSC-106	1"-8	19	2 1/4"-14	26	39	5/16"-18UN	12	4.4
RSC-108	1"-8	19	2 1/4"-14	26	39	5/16"-18UN	12	5.4
RSC-1010	1"-8	19	2 1/4"-14	26	39	5/16"-18UN	12	6.4
RSC-1012	1"-8	19	2 1/4"-14	26	39	5/16"-18UN	12	6.8
RSC-1014	1"-8	19	2 1/4"-14	26	39	5/16"-18UN	12	8.2
RSC-151	1"-8	25	2 3/4"-16	30	47	3/8"-16UN	12	3.3
RSC-152	1"-8	25	2 3/4"-16	30	47	3/8"-16UN	12	4.1
RSC-154	1"-8	25	2 3/4"-16	30	47	3/8"-16UN	12	5.0
RSC-156	1"-8	25	2 3/4"-16	30	47	3/8"-16UN	12	6.8
RSC-158	1"-8	25	2 3/4"-16	30	47	3/8"-16UN	12	8.2
RSC-1510	1"-8	25	2 3/4"-16	30	47	3/8"-16UN	12	9.5
RSC-1512	1"-8	25	2 3/4"-16	30	47	3/8"-16UN	12	10.9
RSC-1514	1"-8	25	2 3/4"-16	30	47	3/8"-16UN	12	11.8
RSC-251	1 1/2"-16	25	3 5/16"-12	49	58	1/2"-13UN	19	5.9
RSC-252	1 1/2"-16	25	3 5/16"-12	49	58	1/2"-13UN	19	6.4
RSC-254	1 1/2"-16	25	3 5/16"-12	49	58	1/2"-13UN	19	8.2
RSC-256	1 1/2"-16	25	3 5/16"-12	49	58	1/2"-13UN	19	10.0
RSC-258	1 1/2"-16	25	3 5/16"-12	49	58	1/2"-13UN	19	12.2
RSC-2510	1 1/2"-16	25	3 5/16"-12	49	58	1/2"-13UN	19	14.1
RSC-2512	1 1/2"-16	25	3 5/16"-12	49	58	1/2"-13UN	19	16.3
RSC-2514	1 1/2"-16	25	3 5/16"-12	49	58	1/2"-13UN	19	17.7
RSC-308	1 1/2"-16	25	3 5/16"-12	49	—	—	—	18.1
RSC-502	—	—	5"-12	55	95	1/2"-13UN	19	15.0
RSC-504	—	—	5"-12	55	95	1/2"-13UN	19	19.1
RSC-506	—	—	5"-12	55	95	1/2"-13UN	19	23.1
RSC-5013	—	—	5"-12	55	95	1/2"-13UN	19	37.6
RSC-756	—	—	5 3/4"-12	44	—	—	—	29.5
RSC-7513	—	—	5 3/4"-12	44	—	—	—	59.0
RSC-1004	—	—	6 7/8"-12	44	—	—	—	33.1
RSC-1006	—	—	6 7/8"-12	44	139	3/4"-10UN	25	59.0
RSC-1008	—	—	6 7/8"-12	44	139	3/4"-10UN	25	59.0
RSC-10010	—	—	6 7/8"-12	44	139	3/4"-10UN	25	72.6

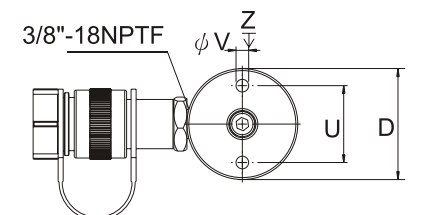
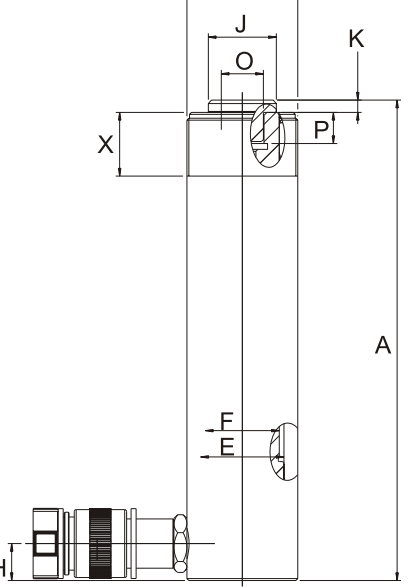
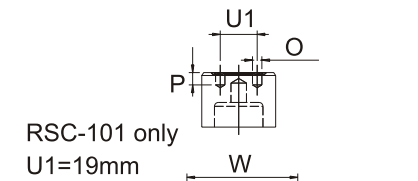
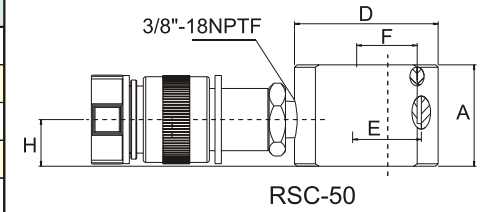
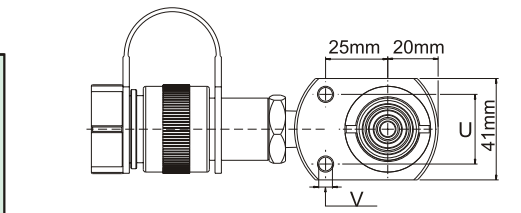

RSC-51 to RSC-5013 models
(see page 16)

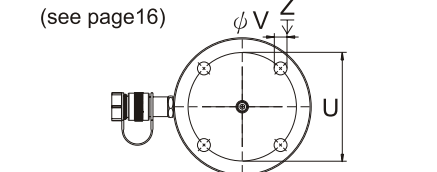

RSC-1006 and RSC-10010 models